

Rev	Redrower	Date	Modification
A	Sugiyama	2019.2.25	初版

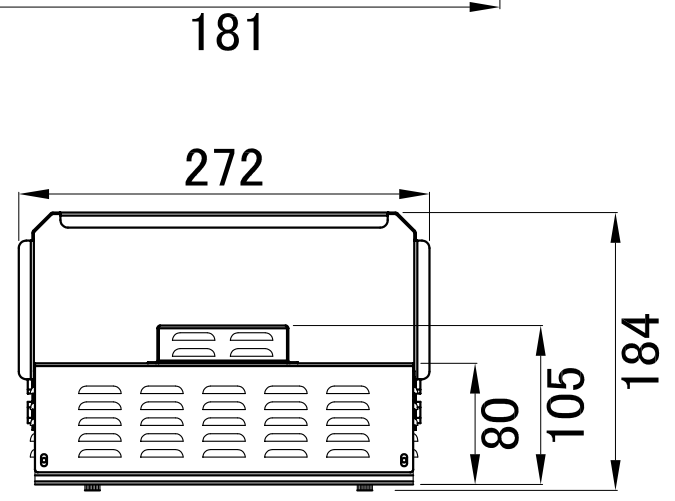
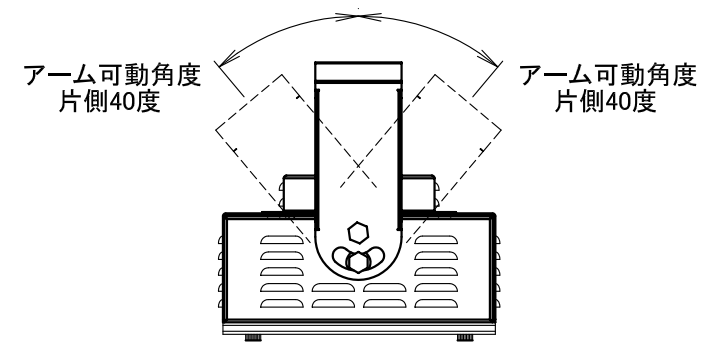
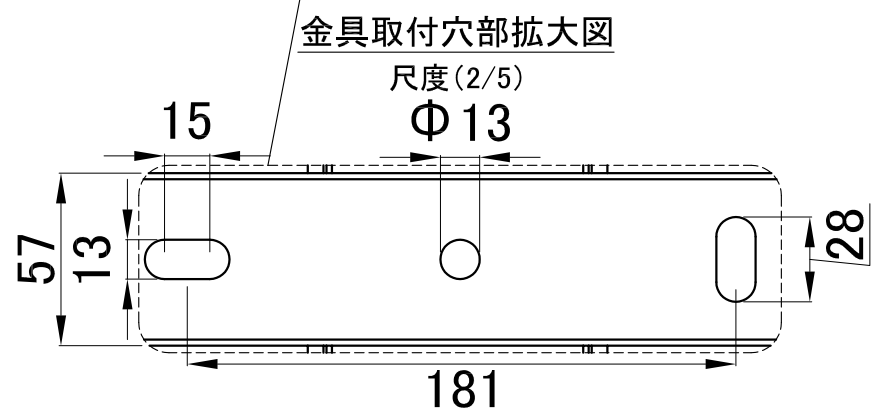
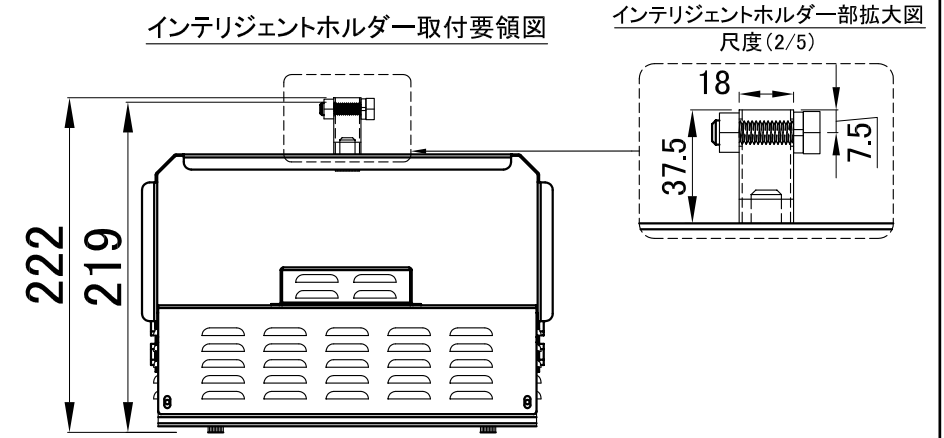
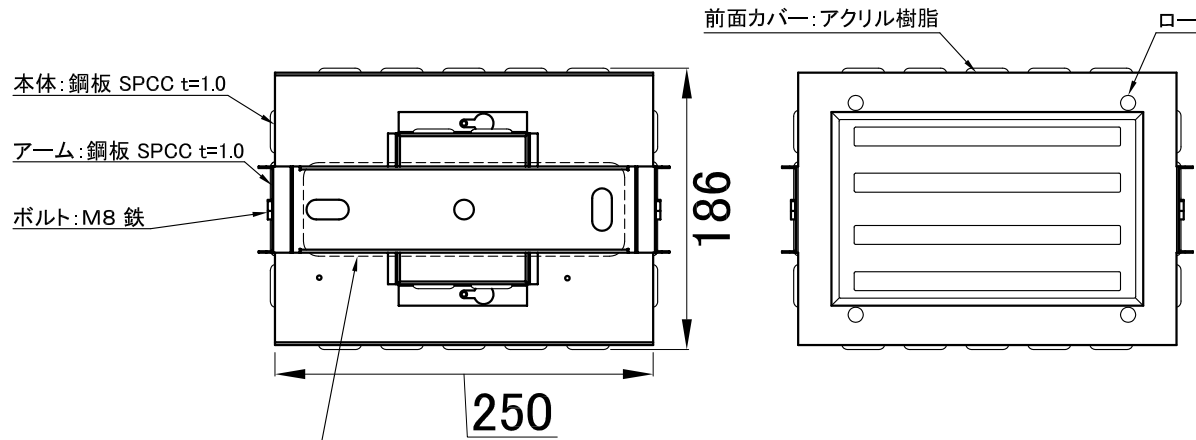

単位: mm

Presented by		株式会社ダイク		
Drowed by	Sugiyama	2019.2.25	Scale	1 / 5 trigonometry
Approved by	Mitaki	2019.2.25	Design Name MH-501-82W 外形図	
Customer	技術資料		Design Num	Revision
Date	2019.2.25		DA4-00296	A