

Rev	Redrower	Date	Modification
A	Sugiyama	2016.8.25	初版

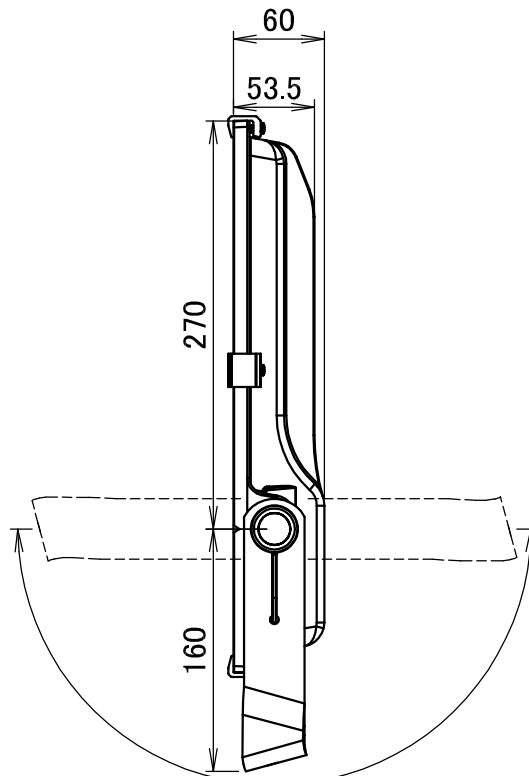

180度  
アーム可動角度

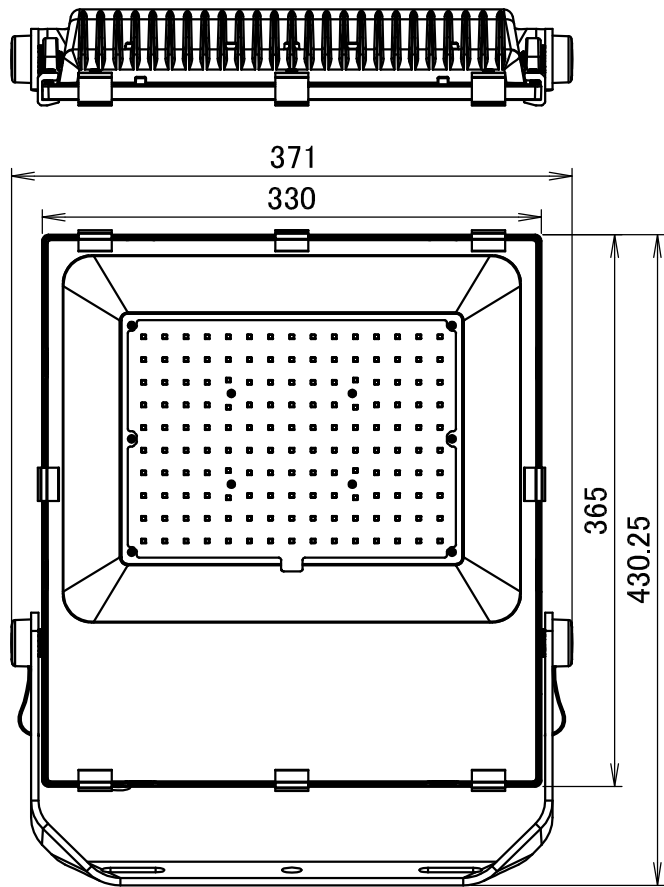
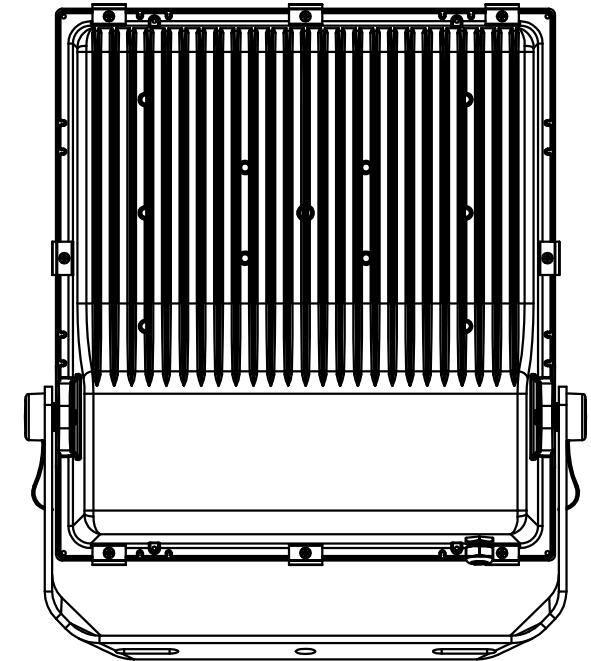

取付金具寸法

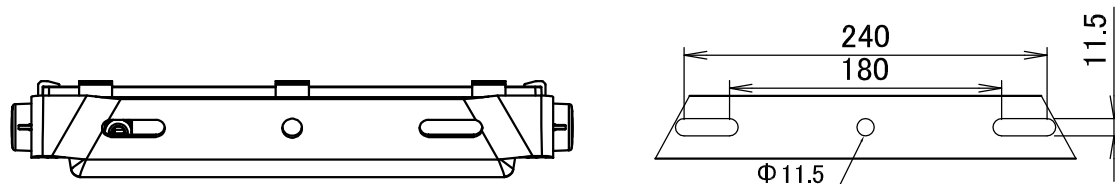

単位:mm

Presented by		株式会社ダイク		
Drowed by	Sugiyama	2016.8.25	Scale	1 / 5 trigonometry
Approbed by	Mitaki	2016.8.25	Design Name FH-257 外形図	
Customer	技術資料		Design Num	Revision
Date	2016.8.25		DA4-00273	A