

Rev	Redrower	Date	Modification
A	Sugiyama	2018.11.26	初版

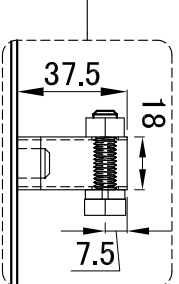

金具取付穴部拡大図

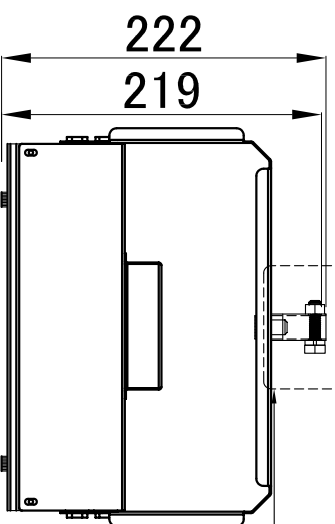
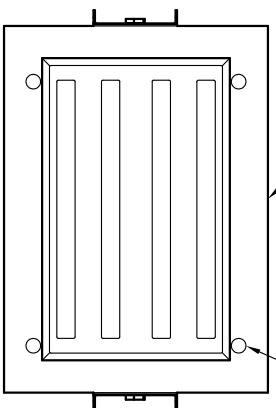
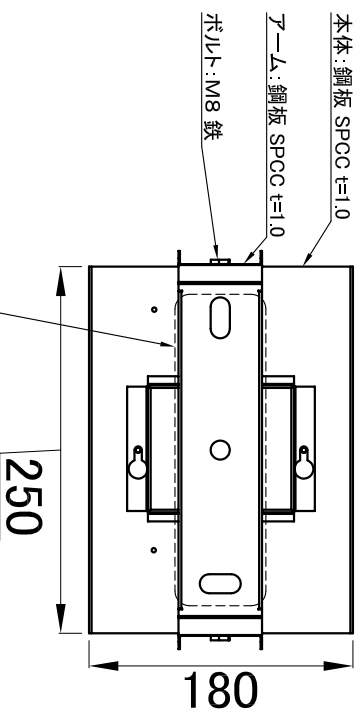
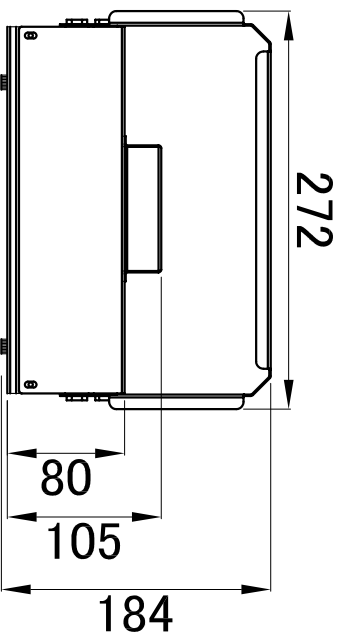
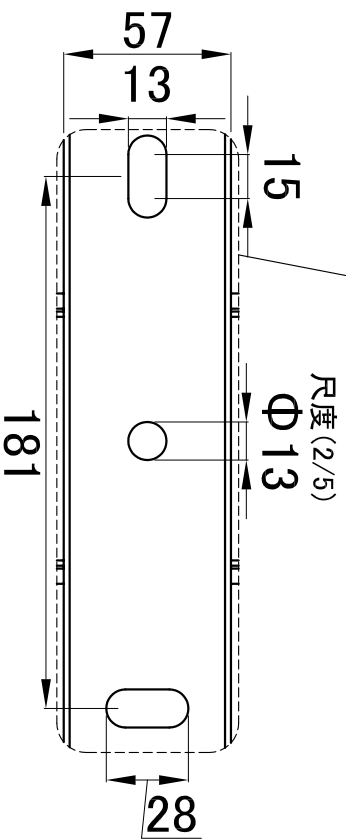

インテリジェントホルダー取付要領図

インテリジェントホルダー一部拡大図  
尺度(2/5)

アーム可動角度  
片側40度

アーム可動角度  
片側40度

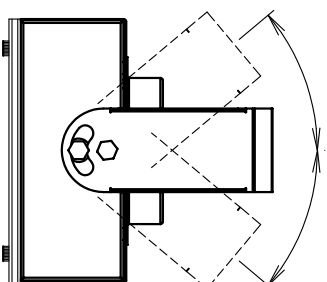

単位: mm

Presented by				株式会社ダイタク			
Drowed by	Sugiyama	2018.11.26	Scale	1 / 5	trigonometry		
Approbred by	Mitaki	2018.11.26	Design Name	MH-501-82W 外形図			
Customer	技術資料		Design Num	DA4-00296		Revision	A
Date	2018.11.26						