

Rev	Redrower	Date	Modification
A	Sato	2012.07.04	初版
B	Sugiyama	2015.05.07	適正差込み長、パイプ径追記

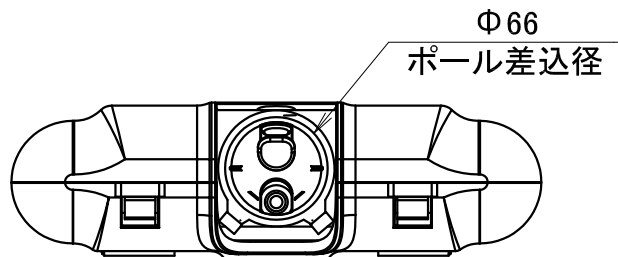
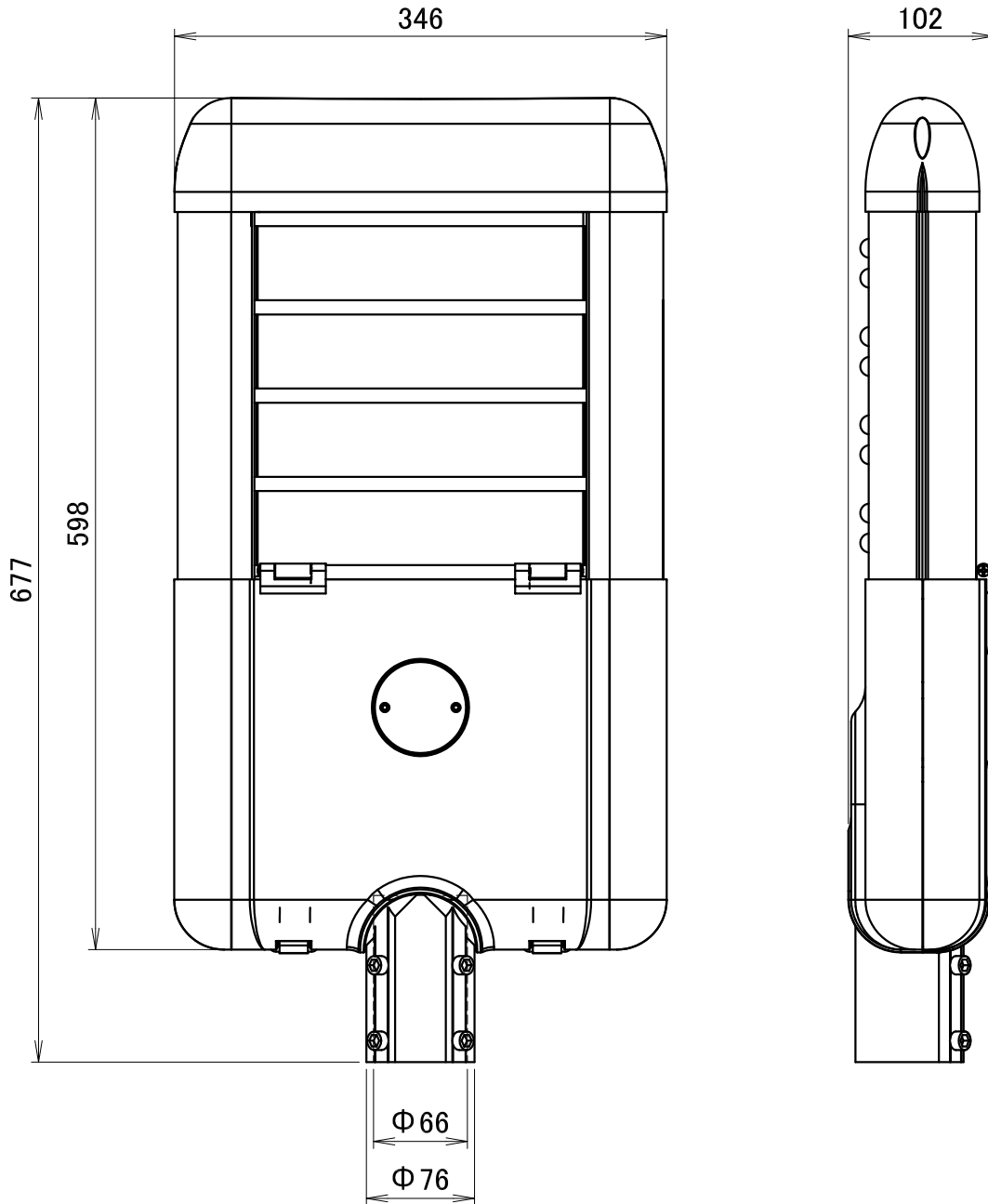

適正差込み長 80~115mm
適正パイプ径 Φ60.5mm

Presented by		株式会社ダイク		
Drowed by	Ryota Sato	2012.07.04	Scale	1 / 5 trigonometry
Approbed by	Kenji Arata	2012.07.04	Design Name SH-221-120W 外形図	
Customer	技術資料		Design Num	Revision
Date	2012.07.04		DA4-00077-4	B